









VENTURA DOOR SYSTEM MAINTENANCE

Image	Description	TDS/VS Part Number
	<p>MULTIPURPOSE GREASE LITHEP EP2 (400g) FOR IG & PS SPIRAL CABLE SHAFTS</p>	<p>ADH014</p>
	<p>ARCANOL MULTITOP GREASE (400g) FOR PSE & RSE BEARING HOUSINGS</p>	<p>ADH015</p>
	<p>PS CABLE TENSION GAUGE FOR PS & RS DOOR MECHANISMS</p>	<p>K306</p>
	<p>MOLEX MICRO-FIT PIN CRIMPING TOOL</p>  <p>FOR USE WITH E135/E136 VS PIN CONNECTIONS</p>	<p>TR-009 VB8315</p>
	<p>TORQUE WRENCH KIT 20- 100N + 3x OPEN END 13,17,19 INSERT TOOLS</p>	<p>TR-035</p>

 <p>The image shows a doorshaft torque tool for IG4 glider doors. It consists of a yellow metal bracket with a serrated edge, a brass gear, and a white plastic washer. The number '70,5' is printed on the bracket.</p>	<p>DOORSHAFT TORQUE TOOL FOR IG4 GLIDER DOORS</p>	<p>VA3860</p>
 <p>The image shows a doorshaft torque tool for IG3 glider doors. It consists of a yellow metal bracket with a serrated edge, a brass gear, and a white plastic washer. The numbers '85,0' and '85,5' are printed on the bracket.</p>	<p>DOORSHAFT TORQUE TOOL FOR IG3 GLIDER DOORS</p>	<p>VA4146</p>
 <p>The image shows the Ventura V-Diag diagnostic kit in its black carrying case. The case is open, revealing a laptop, various cables, and a diagnostic module. The kit is used for diagnosing IGE, PSE, and RSE door controllers.</p>	<p>VENTURA V-DIAG DIAGNOSTIC KIT (END USER VERSION) FOR IGE,PSE & RSE DOOR CONTROLLERS</p>  <p>The image shows two diagrams of door controllers. The left diagram is a front view of a rectangular controller with a circular indicator and several ports. The right diagram is a side view of the same controller, showing its profile and mounting points.</p>	<p>VB2110</p>

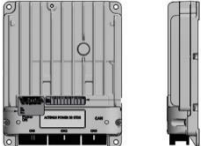
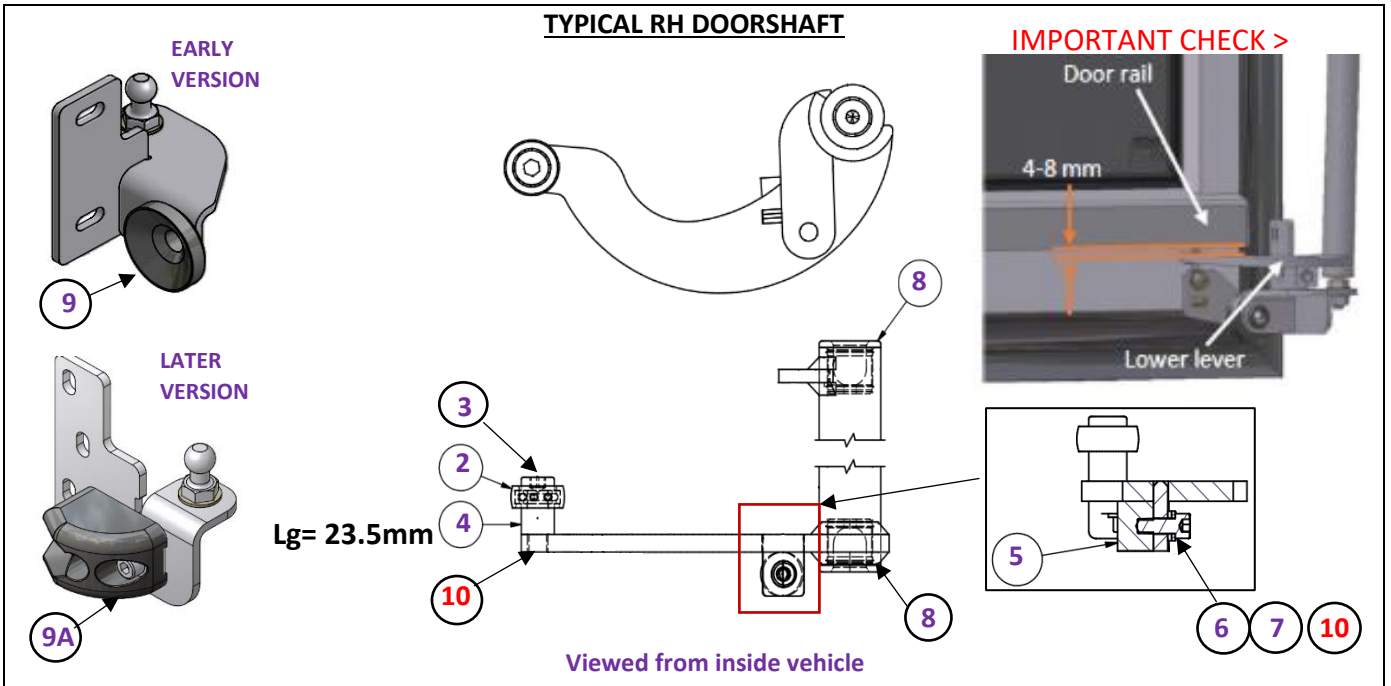

KIT COMPONENT PARTS

THIS IS A SINGLE DOORSHAFT/LEAF KIT, 2 REQUIRED PER DOUBLE DOOR SET

(2) H750 = GUIDE ROLLER ASSY		(7) A732 = M6 A2 WASHER x 2	
(3) B706 = M10x40 FIXING BOLT		(8) B689 = DOORSHAFT BEARING BUSH x 2	
(5) C492 = VIBRATION DAMPER Ø20x15		(9) D803 = BOTTOM SUPPORT CATCH BLOCK	
(4) D760 = ROLLER SPACER BUSH Ø16o/d x Ø10i/d x 23.5 Lg		(9A) J405 = BOTTOM SUPPORT CATCH BLOCK	
(6) A760 = M6x16 FIXING BOLT		(10) C265 = LOCTITE 243 for items 3 & 6 # 2ml measure in kit	

ASSOCIATED CATCH PIN/WEDGE PLATES : REF ONLY NOT SUPPLIED IN KIT (AVAILABLE ON REQUEST)

<p>D545 LH CATCH PIN ON PLATE</p>	<p>D546 RH CATCH PIN ON PLATE</p>	<p>E097 LH CATCH PIN ON PLATE</p>	<p>E096 RH CATCH PIN ON PLATE</p>
<p>I275 LH CATCH WEDGE</p>	<p>I276 RH CATCH WEDGE</p>	<p>C924 CATCH PIN</p>	<p>M801 CHECK IF REQ'D GUIDE ROLLER SECURING KIT SEE DOC SME013E</p>

IF IN DOUBT ON PART SELECTION - PLEASE CONTACT US WITH DETAILS FROM THE DOOR LABEL ATTACHED TO TOP OF LEAF >



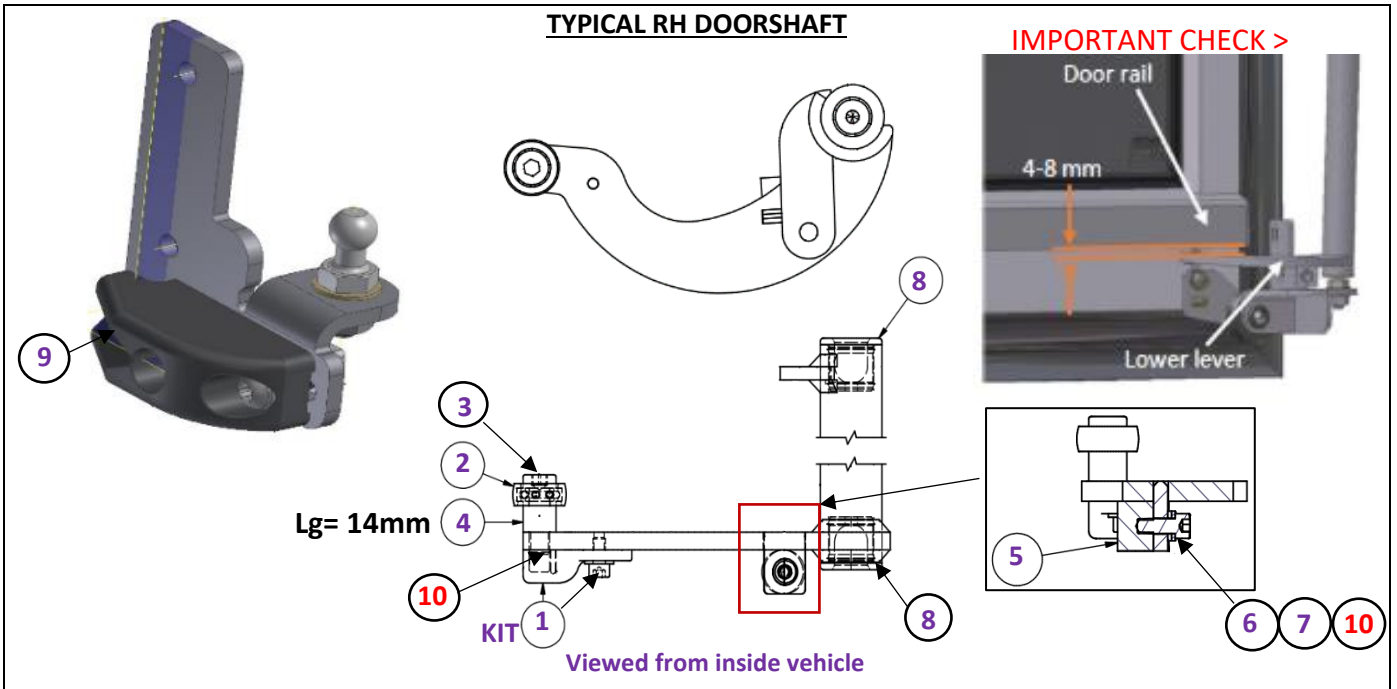



KIT COMPONENT PARTS

THIS IS A SINGLE DOORSHAFT/LEAF KIT, 2 REQUIRED PER DOUBLE DOOR SET

(1) KIT601 = LEVER BLOCK KIT Comprising of item 1.1, 1.2, & 1.3	(4) G968 = ROLLER SPACER BUSH Ø16xØ10 Lg=14mm	
(1.1) J593 = LEVER BLOCK	(6) A760 = M6x16 FIXING BOLT	
(1.2) D806 = M6x12 FIXING BOLT	(7) A732 = M6 A2 WASHER x 2	
(1.3) E009 = M6 LOCKING DISK	(8) B689 = DOORSHAFT BEARING BUSH x 2	
(2) H750 = GUIDE ROLLER ASSY	(9) P261 = BOTTOM SUPPORT CATCH BLOCK	
(3) B486 = M10x30 FIXING BOLT	(10) C265 = LOCTITE 243 for items 3 & 6 # 2ml measure in kit	
(5) C492 = VIBRATION DAMPER Ø20x15		

ASSOCIATED CATCH PIN/WEDGE PLATES : REF ONLY NOT SUPPLIED IN KIT (AVAILABLE ON REQUEST)

O281 = LH CATCH PLATE WEDGE LH	O282 = RH CATCH PLATE WEDGE
	

IF IN DOUBT ON PART SELECTION - PLEASE CONTACT US WITH DETAILS FROM THE DOOR LABEL ATTACHED TO TOP OF LEAF >

