

**DOOR MANUAL: INST-103-05 PART 2 of 2**  
**RH GLIDER ENTRANCE ELECTRIC DOOR SYSTEM**  
**for TREKA-16/24 DDA**

- SPARE PARTS IMAGES
- PRE-ASSY & CABLE LOOMS
- SHELFPLATE ASSEMBLY DATA
- ENTRANCE DOOR ASSEMBLY DATA
- TYPICAL TOOL REQUIREMENTS & STD TORQUE SETTINGS
- TDS SERVICE ENGINEER REQUEST SHEET



43 Broton Drive, Halstead, Essex, CO9 1HB.  
Email: [sales@transportdoorsolutions.co.uk](mailto:sales@transportdoorsolutions.co.uk)

Tel: 01787 473000 Fax: 01787 477040  
[www.transportdoorsolutions.co.uk](http://www.transportdoorsolutions.co.uk)

# SPARE PARTS IMAGE SHEET for TREKA-16/DDA



FULL PRODUCTION ASSEMBLY FITTINGS/FIXINGS AVAILABLE ON REQUEST FOR SPARE PARTS



**HRL025-YEL1021**  
RH HANDRAIL.



**EWL212-03**  
NC. REED SWITCH  
ASSY.

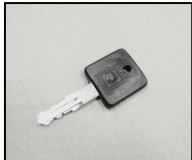

**LCK100A**  
SPARE KEY.

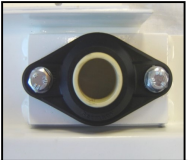

**BRG022B**  
SPH FLANGE  
BRG.



**HDL007T-J2**  
LOCK HANDLE  
KIT.



**HDL001A**  
PULL HANDLE.



**GDE001**  
GUIDE SHOE.

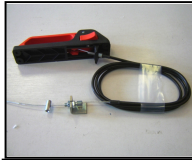

**HDL003T-002**  
EMERG'Y  
HANDLE KIT-ASSY

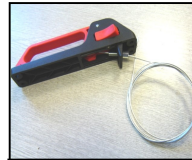

**HDL003T-003**  
EMERG'Y  
HANDLE +CABLE.



**LCK302-2000**  
INNER  
CABLE 1.5x2mtrs



**HDL003A**  
EMERG'Y HANDLE.



**BUT010-ASY**  
INT'L EMRG'Y  
OPEN

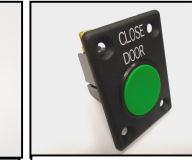

**BUT012-ASY**  
INT'L CLOSE  
BUTTON

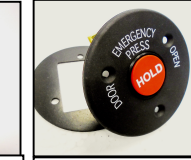

**BUT046-ASY**  
EXT'L OPEN  
BUTTON



**L500-05-ASSY-01**  
UPPER BRG  
ASSY.



**BRK002-01**  
DOORGUIDE  
BRACKET

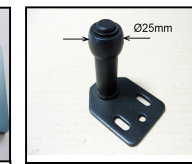

**ASY006B**  
BOTTOM  
BEARING



**ASY003B**  
UPPER GUIDE  
SPINDLE

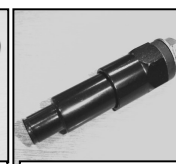

**ASY017T**  
LOWER GUIDE  
SPINDLE



**L500-09-ASSY-01**  
LOWER BRG  
ASSY.

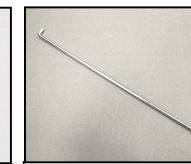

**ROD001A**  
LOCK ROD 236x4



**BSA3807-740-01**  
HORZ BRUSH  
ASSY

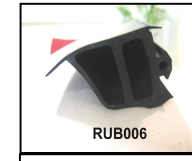

**RUB006**  
DOOR NOSING  
RUBBER



**BRG007B**  
Ø12 SPH ROD  
END

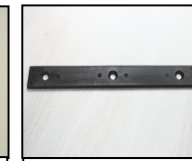

**L500-51-192**  
DOOR ARM SLIDE  
RAILS



**CRK002A**  
R66 CRANK ARM

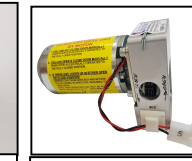

**ELE171T-02** 12V  
E-DRIVE MOTOR  
PRE-ASSY KIT



**LCK103A**  
SLIDING SUPPORT  
& LOCK PIN



**ATF2-244-25**  
RH LEADING FLAP  
ASSY



**ATF1-380-25**  
RH TRAILING FLAP  
ASSY



**RUB011A**  
PORTAL  
RUBBER SEAL



**SAB030ASSY**  
RH ABS SABOT  
ASSY 640x98 BLK

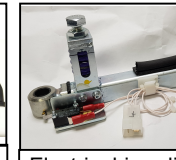

Electric drive slide  
clutch assy  
REF ONLY

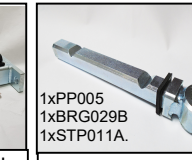

**ASY200T-01**  
100mm SLIDE  
CLUTCH ARM ASSY

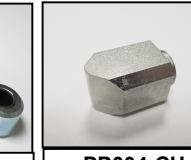

**PP004-CH**  
CLUTCH PIN



**SPG003A**  
CLUTCH  
SPRING



**STP011**  
RUBBER END  
STOP, TRIM

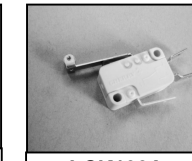

**LCK103A**  
SLIDING SUPPORT  
& LOCK PIN



**GER601**  
PULLEY BELT  
177-3M-09

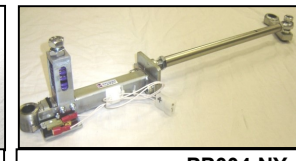

**PP004-NY**  
NYLON CLUTCH PIN.  
USED ONLY FOR MANUAL DRIVE UNITS

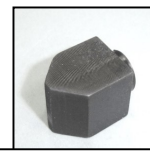



# SHELFPLATE ASSEMBLY DATA

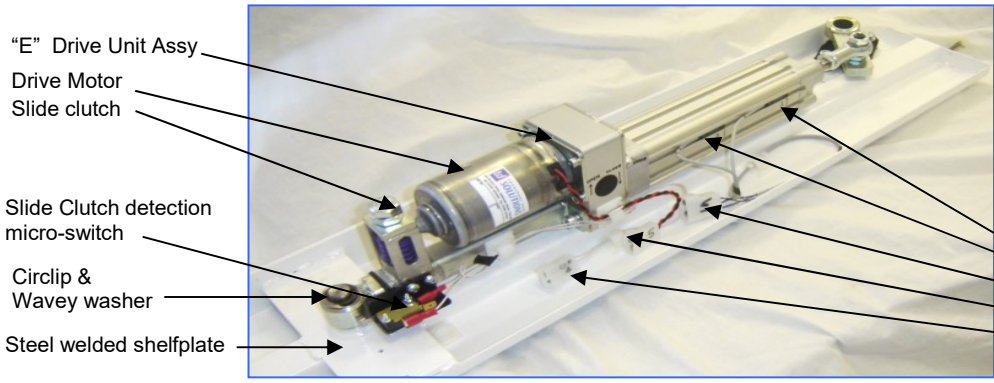

"E" Drive Unit Assy  
 Drive Motor  
 Slide clutch  
 Slide Clutch detection micro-switch  
 Circlip & Wavey washer  
 Steel welded shelfplate

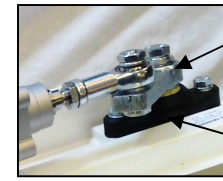

Crank Arm. Rad=66mm  
 Door shaft  
 Top Bearing

No.1 = Door Open reed switch  
 No.2 = Door Close reed switch  
 CON.6 =4-way tab connector. Reed switches  
 CON.5 =2-way tab connector. Motor  
 CON.4 =2-way tab connector. Clutch switch

Part No/Code	Description	
CYL050-12-02	12V "E" DRIVE 100STR UNIT ASSY =CLUTCH, R/SWS, M/SW	
CYL050-24-02	24V "E" DRIVE 100STR UNIT ASSY = CLUTCH, R/SWS, M/SW	
ELE031T-01	12V DRIVE MOTOR ASSY	INST-014-08
ELE025T-01	24V DRIVE MOTOR ASSY	INST-014-09
ASY201T	SLIDE CLUTCH STD (PURPLE) 100mm STR	INST-014-06

## ELE031T-01= 12v DRIVE MOTOR PRE-ASSY & CABLE LOOM ELE025T-01= 24v DRIVE MOTOR PRE-ASSY & CABLE LOOM

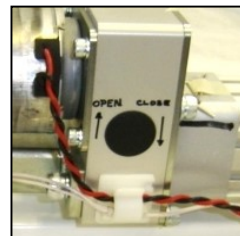
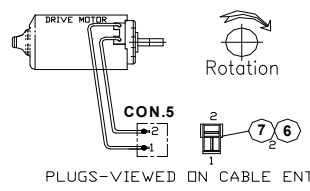
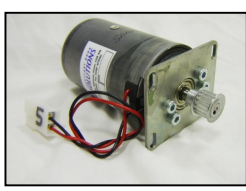

Manually operation of Drive Unit.  
 Only when Plug.5 is disconnected.  
 See instruction label on side of motor

## EWL212-01= SLIDE CLUTCH DETECTION SWITCH KIT LOOM

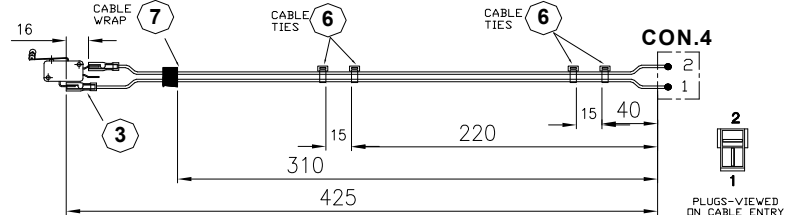
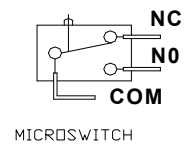

## EWL212-03= REED SWITCH (NC.) LOOM

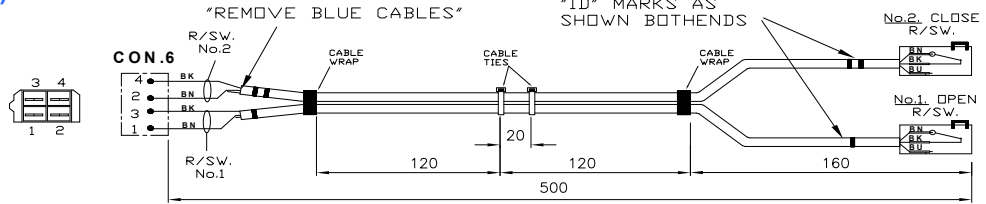
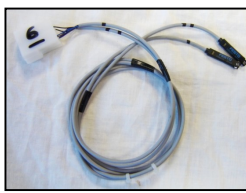

## ASY201T-01= 100str SLIDE CLUTCH (PURPLE SPRING) ASSY (INST-014-06-A1= SLIDE CLUTCH ASSEMBLE INSTRUCTIONS)

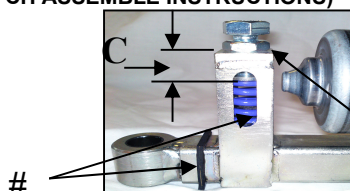

SLIDE CLUTCH.  
 Pre-set at factory. Release locking nut, compress or release to suit operation, over-ride or door retaining force of 150N  
 NOTE: # = Clutch is in the fully engaged position.  
 "C" Electric drive =15mm +1.5 -0.0  
 "C" Manual drive= 11mm +/- 1.0

## CYL050-12-02= 12V "E" DRIVE 100str UNIT ASSY +CLUTCH,R/SWS & M/SW CYL050-24-02= 12V "E" DRIVE 100str UNIT ASSY +CLUTCH,R/SWS & M/SW

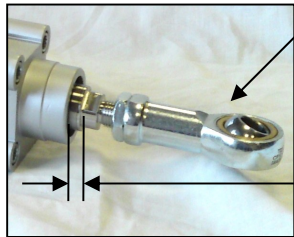
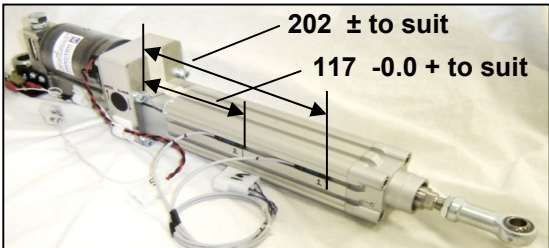

M12 x 1.25 ROD END  
 For adjustment lift off rod end from crank arm spindle with door in open position. Release lock nut, then rotate rod end to suit.  
**DO NOT ROTATE "E" DRIVE PISTON**  
 5mm minimum  
 When door is fully closed

Micro-switches Pre-set at production stage

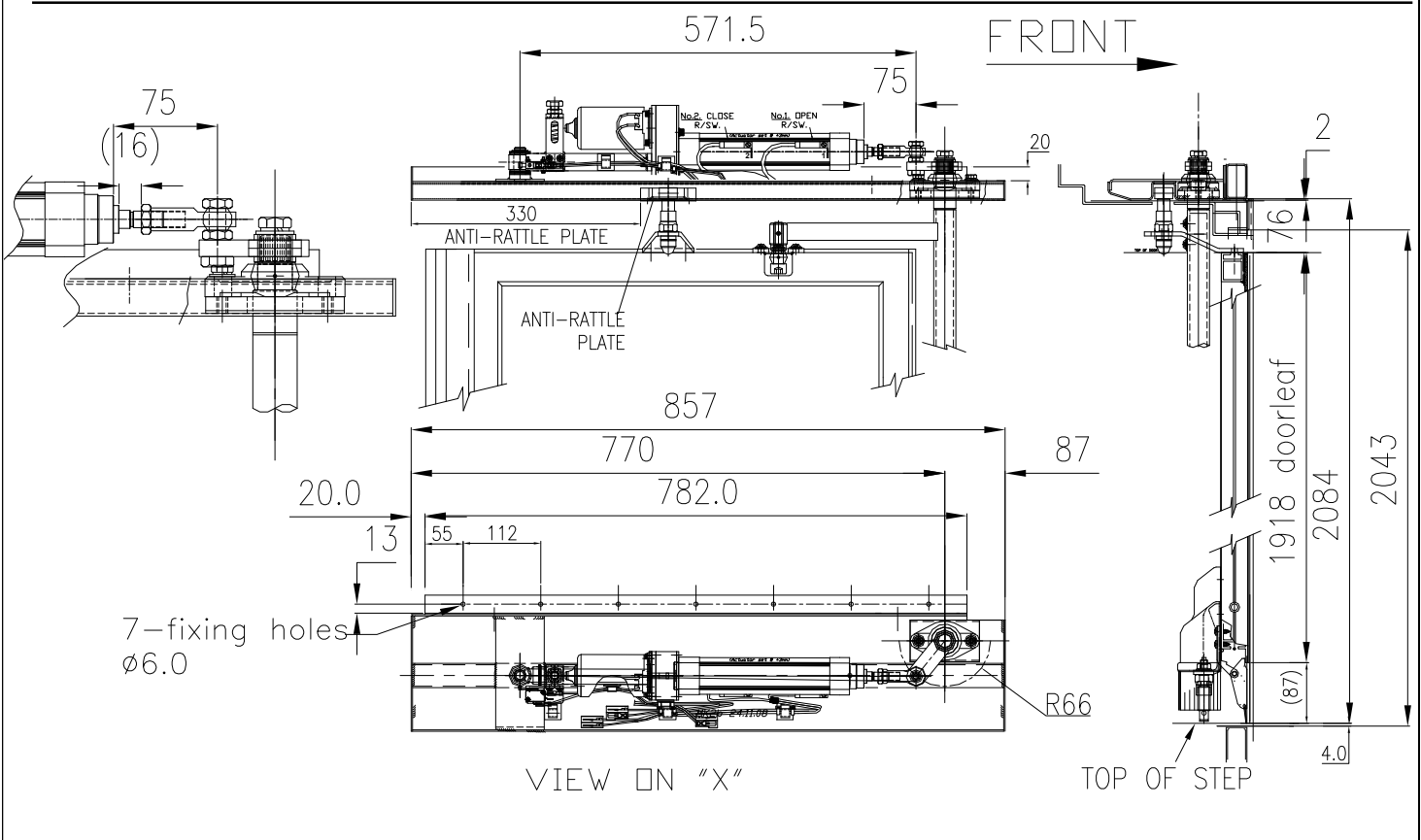
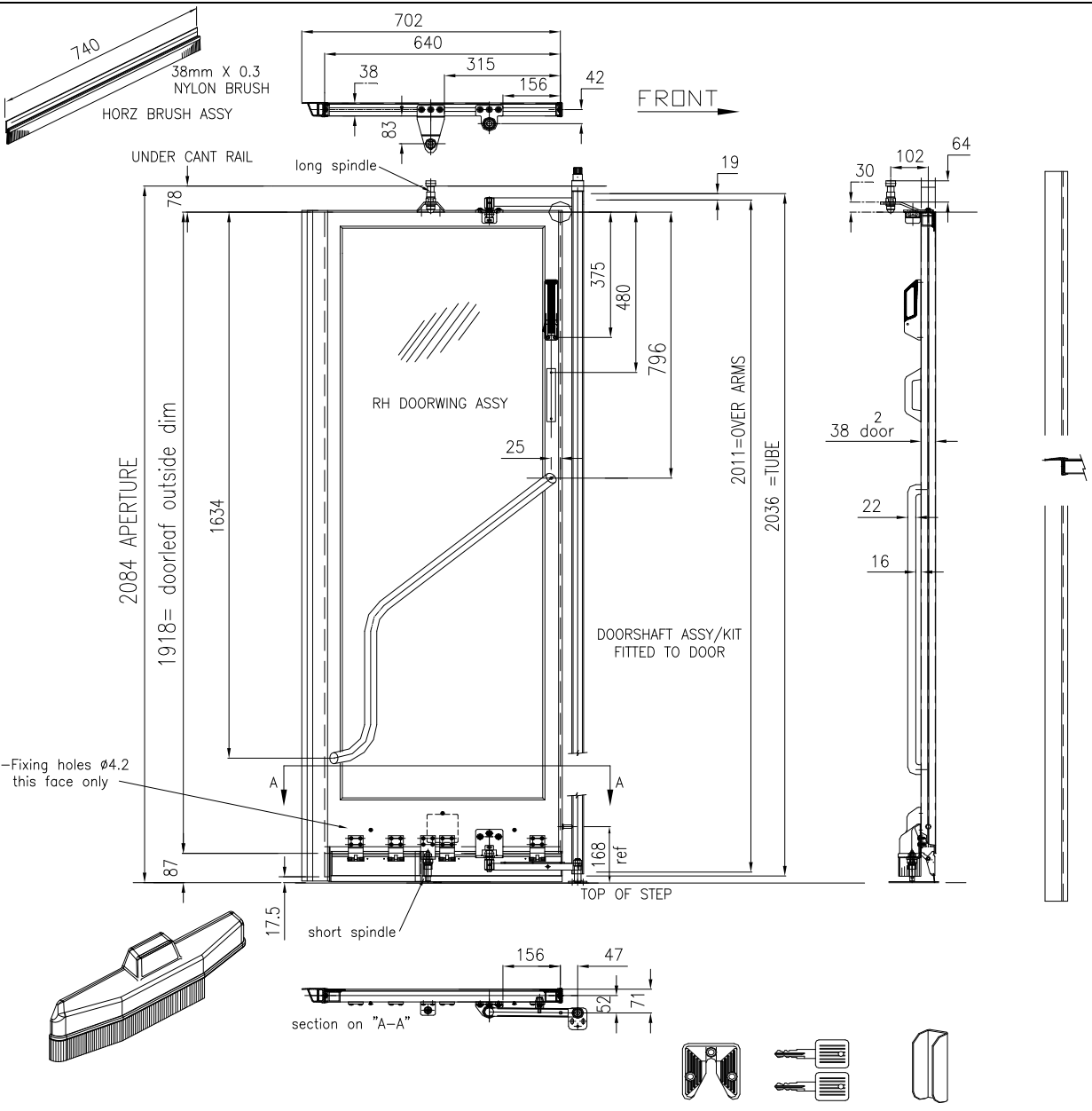





# TYPICAL TOOL REQUIREMENTS & STANDARD TORQUE SETTINGS



SPANNERS	ALLEN KEYS
<b>Open &amp; Closed Ended</b>	<b>Hex &amp; Ball Nose Ends</b>
24, 23, 22, 19, 17, 16, 13, 12, 10, 8, 7, 4, mm A/F	1.5, 2.0, 2.5, 3.0, 4.0, 5.0, 6.0, 8.0, 12. mm A/F
<b>Adjustable Spanner</b>	<b>Tee Bar Type</b>
Up To 25mm Opening S-M-L	3.0, 4.0, 5.0, 6.0, 8.0.
<b>Sockets</b>	



“SCREW DRIVERS BITS”	MISCELLANEOUS
4mm Flat Blade Screwdrivers (S-M-L)	Internal & External Circlip Pliers
No.PZ2 Pozi-Drive Screwdriver	Pliers flat & tapered ends
No.PZ2 Pozi-Drive Bit	Stanley Knife
No.PZ3 Pozi-Drive Bit	Scissors
	Hammer small Combination type



NUT TIGHTENING TORQUE	
M6	7 Nm
M8	17 Nm
M10	36 Nm
M12	55 Nm
M14	80 Nm
M16	120 Nm

BOLT / SCREW TIGHTENING TORQUE	
M6	12 Nm
M8	25 Nm
M10	52 Nm
M12	94 Nm
M16	90 Nm
M20	150 Nm

# TDS Service Engineer Request Sheet



Report Number : **SER** \_\_\_\_\_ Allocated by TDS

Operator: \_\_\_\_\_ Date: \_\_\_\_\_

Location: \_\_\_\_\_ Contact Name: \_\_\_\_\_

\_\_\_\_\_ Tel. No: \_\_\_\_\_

Vehicle Type: \_\_\_\_\_ Fleet/Body No: \_\_\_\_\_

Reg No: \_\_\_\_\_ Mileage: \_\_\_\_\_

Warranty/ Chargeable? \_\_\_\_\_ Customer Order No/Warranty Ref: \_\_\_\_\_

OFFICE USE ONLY

**Nature Of Problem:**

**Cause:**

**Corrective Action Taken:**

**Parts Used:**

	Site time:		Hrs:		TDS Stock Issued	Yes/no
	Travel time:		Hrs:		Service Agent Stock Issued	Yes/no
	Total time:		Hrs:		Other	Yes/no

**Customer Sign Off:** \_\_\_\_\_ **Date:** \_\_\_\_\_ **Time:** \_\_\_\_\_

**Printed Name:** \_\_\_\_\_

**Service Engineer:** \_\_\_\_\_

**Service Agent:** \_\_\_\_\_

**NOTE IF PARTS NOT FOUND NOT TO BE DEFECTIVE AFTER INVESTIGATION, WE RESERVE THE RIGHT TO RECOVER MATERIAL AND LABOUR COSTS**