

Ventura Systems Tools

Tool: Torque wrench tool
Part number: VA4146
Application: Inward Gliding Door 3

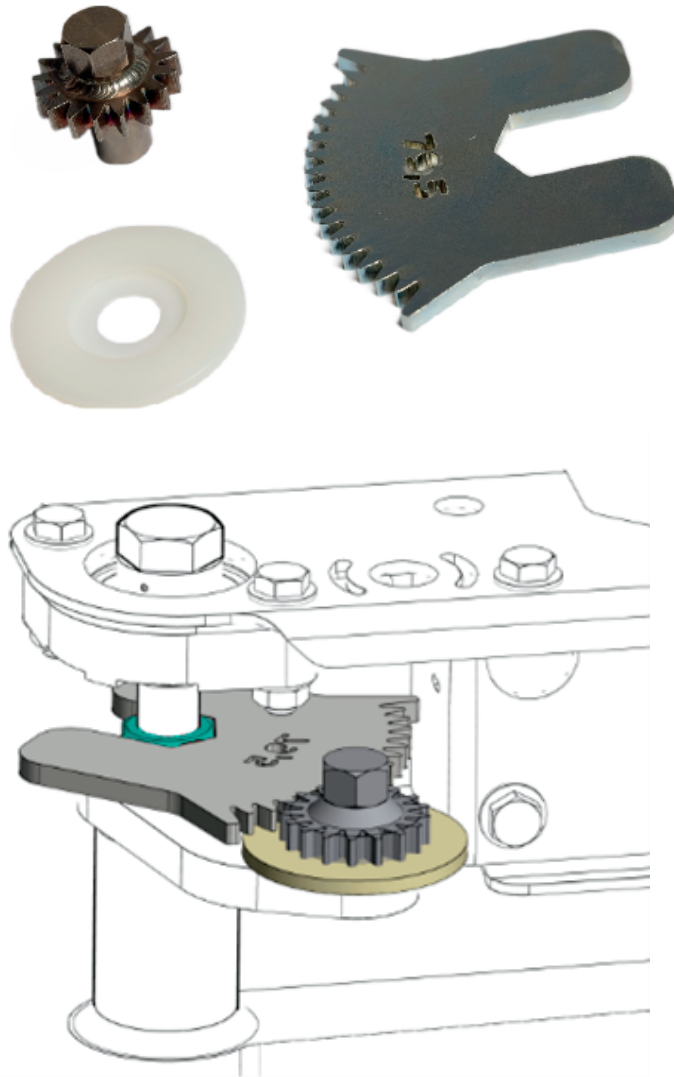

Description

To secure the door leaf in its adjusted height position the secure nut on top of the door shaft needs to be tightened. The torque wrench tool can be used in case the secure nut is hard to reach due to environmental limitations. This tool ensures far better reachability and much less needed torque, therefore this tool can enhance quality of the final product and reduce installation time. For the correct use of torque wrench tool consult the service instruction.

Disclaimer: maintenance, calibration and proper use of tooling is the responsibility of the customer.